

Model 41 *Interface*

User Guide

Issue 2, February 2007

This User Guide is applicable for serial numbers:
M41-00230 and later with software version 1.1 and higher

Copyright © 2007 by Studio Technologies, Inc., all rights reserved
www.studio-tech.com

This page intentionally left blank.

Table of Contents

Introduction	5
Installation	8
Post-Installation	12
Operation	13
Troubleshooting	16
Technical Notes	18
Specifications	22
Appendix A	23
Block Diagram	

Model 41

Interface

This page intentionally left blank.

Introduction

The Model 41 is designed to create broadcast-standard IFB circuits from line-level audio sources. The unit's primary application is to interface analog outputs associated with digital matrix intercom systems with broadcast IFB user devices. The Model 41 provides four independent IFB circuits. Each IFB circuit provides DC power and two analog audio signals to support the connected IFB user devices. The Model 41's audio quality is excellent; little hiss, hum, or other artifacts are present. To ensure optimal operation, the unit provides resources for visually and audibly monitoring the audio output signals. In addition, the DC output voltage is monitored for over-current and short circuit conditions.

Installation of the Model 41 is very simple. Audio input connections are made using a 25-pin D-subminiature connector. The IFB output circuits interface using standard 3-pin XLR-type connectors. The compact, one-rack-space package is constructed using heavy-gauge steel components. The unit's mains power input can range from 100 to 230 volts, 50/60 hertz. This "universal input" ensures correct operation virtually anywhere in the world.

There may be persons not familiar with the term IFB. That's not unreasonable as it's a somewhat obscure acronym for interruptible foldback. On its own, the term foldback is an alternate way of describing a cue or monitor function. Adding "interruptible" before it means that the cue source can be temporarily replaced with an audio signal originating from a producer, director, or other production personnel. IFB circuits are often used in the broadcast industry for talent cueing applications, both in studio and field settings. Both "dry" and "wet" IFB circuits can be deployed and their characteristics are worth reviewing. The term "dry" IFB typically refers to a transformer-balanced line-level audio circuit with a nominal level in the range of 0 to +8 dBu. This is essentially a standard audio circuit that is commonly used to interconnect audio equipment. The term "wet" IFB refers to a circuit that combines DC power and one or two channels of analog audio. The nominal level of the DC power source is typically in the range of 30 to 32 volts. The audio is unbalanced with a typical nominal level of -10 dBu. The Model 41 implements wet IFB circuits. As such, in this user guide the term IFB will always represent this type of circuit.



Model 41 Front Panel

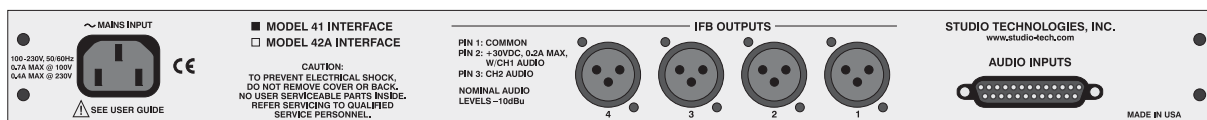

Model 41 Back Panel

IFB circuits provide an effective means of delivering power and two channels of audio to user devices by means of standard audio cables. These cables, ubiquitous to the audio industry, interface using 3-pin male and female XLR-type connectors. Using IFB circuits and standard audio cables it's a simple matter to support user devices such as listen-only belt packs and announcer's consoles with no external power source required. Whether the IFB source and user devices are 100 or 1000 feet apart, reliable operation can almost always be provided.

In many cases, the Model 41 Interface will be used in on-air television applications. Whether installed in a fixed location or as part of a remote facility, the unit is capable of providing excellent performance. In addition, the Model 41 is applicable for non-broadcast applications. For example, audio recording and post-production facilities can also effectively use the Model 41. Combined with stereo or mono listen-only belt packs, also available from Studio Technologies, a variety of headphone cue systems can easily be deployed. And since the Model 41's audio inputs are compatible with standard line-level audio signals virtually any analog source can be connected.

Four Independent IFB Circuits

The Model 41 supplies four independent IFB circuits. Each circuit consists of two audio inputs and a 2-channel "wet" IFB output. The audio inputs are transformer coupled, have a nominal level of +4 dBu, and are compatible with balanced or unbalanced sources. In on-air television broadcast applications the audio sources will often be analog outputs from matrix intercom systems. Two sources are typically

designated to serve as user cue signals. Generally one source is configured in the matrix intercom system as "interrupt" while the other is configured as "program." An alternate term often used for the "interrupt" channel is "program-with-interrupt." This may be more descriptive as the function is actually a program source that gets interrupted with talkback audio. The "program" channel is typically a continuous source of program audio. An alternate term is "program-only." For other applications, the Model 41's audio inputs can be connected to a 2-channel or stereo audio source. This configuration may prove useful in radio broadcasting, audio-with-picture, or recording studio applications. The specific application will dictate whether both cue signals will be utilized by the end user. In on-air sports broadcast situations a "double-muff" (stereo) headset will provide a user with both audio channels, one for each ear. In interview or news-gathering applications it's common to use a single "earpiece" to provide a user with program-with-interrupt audio.

Maintaining excellent audio performance was a major Model 41 design goal—the hiss, hum, and noise associated with typical IFB circuits was simply not acceptable. The Model 41 meets those requirements with audio that is "on-air" quality: low distortion, high signal-to-noise ratio, and ample headroom. On-air talent and guests, production personnel, and technicians will all appreciate the clean, quiet cue signal.

The Model 41's IFB circuits provide DC power and two channels of unbalanced audio over a single 3-conductor output. The DC output is nominally 30 volts with a maximum rated current of 200 milliamperes. A major strength of the Model 41

is the IFB circuit's ability to effectively deliver DC power over a variety of conditions. Unlike other interface devices that use a common but less-than-ideal circuit topology, a unique IFB circuit was developed by Studio Technologies to achieve the desired performance goals. The result is a major improvement in effectively supporting IFB user devices over a wide range of conditions. Connected devices can draw up to the full rated 200 milliamperes of current with little drop in DC voltage. This output voltage stability is the key—whether drawing 50, 100, or 200 milliamperes, the output will remain close to 30 volts. In practical terms this means that reliable IFB-based cue systems can now be deployed in more stadiums, concert halls, or motor racing facilities than was previously possible; longer cable runs, more user devices, excellent performance.

Audio Monitoring

To help confirm proper installation and ensure correct operation, the Model 41 includes a full-featured audio monitor section. Two 5-segment LED meters provide an indication of the audio levels as they appear directly on the IFB output connectors. This capability makes it simple to adjust and maintain correct audio levels so that optimal IFB performance can be maintained. A headphone output is also provided, allowing “real world” checking of IFB audio quality. In addition to being able to manually select the IFB circuit to be monitored by the meters and headphone output, an “auto scan” mode is also included. This allows each of the four IFB circuits to be monitored in a continuously repeating sequence.

DC Monitoring and Fault Shut Down

To prevent possible damage to the Model 41's output circuitry and connected user devices, the DC output voltage present on pin 2 of each IFB circuit is continually monitored. If the voltage on an IFB circuit falls below 24 volts its associated LED will “flash” as an error indication. If this under-voltage condition continues for more than 4 seconds a shut down mode will be entered, turning off power to the IFB circuit. After a 10-second interval the output will again become active.

Compatibility

The Model 41 is compatible with virtually every digital matrix intercom system, including those from Clear-Com®, Drake, Telex®/RTS®, and Riedel®. Interfacing requires only the connection of analog output ports from the intercom system to the Model 41's audio inputs. Optimal performance might be gained by configuring the nominal audio level of the intercom system's “virtual” IFB output ports to match the Model 41's +4 dBu input level. With the Model 41's excellent audio and power delivery performance it's an ideal alternative to the interface devices offered by the intercom system vendors. Using the Model 41 the intercom system's audio quality can be maintained all the way to the IFB users.

The Model 41's IFB circuits allow virtually every IFB user device to be supported. These include the Model 30-series listen-only belt packs and Model 200-series announcer console products from Studio Technologies. The 200-series units combine a variety of microphone control, headphone monitoring, IFB and intercom system interfacing, and related functions

into compact desktop units. Industry-standard listen-only belt packs from RTS, including the 4020 and 4030, can also be directly supported.

Alternate Applications

In addition to broadcast intercom applications, the Model 41 can be used to create high-performance stereo headphone cue systems. Line-level signals coming from an audio console, a routing switcher, or an off-air receiver can be connected to the Model 41's audio inputs. The IFB circuits can be connected to listen-only belt packs, several models of which are available from Studio Technologies. For example, the Model 35 Talent Amplifier will allow one or two pairs of stereo headphones to be supported. Each of the Model 41's four IFB circuits will support up to six Model 35 Talent Amplifiers.

Installation

In this section you will be installing and interconnecting the Model 41. The one-rack-space unit will be mounted in an equipment rack. Audio input connections will be made by way of a 25-pin D-sub-miniature connector. IFB circuits will be interfaced using four 3-pin XLR-type connectors. AC mains power will be connected by means of a detachable cord that is compatible with the Model 41's 3-pin IEC 320 C14-type inlet connector.

System Components

The shipping carton contains the Model 41 Interface and associated user guide. Units destined for North America and Japan also include an AC mains cord. Your dealer or distributor should provide an AC mains cord for other destinations.

Locating the Model 41

The Model 41's IFB circuits provide DC power and unbalanced audio to operate external IFB user devices. These devices are often IFB "belt packs," broadcast announcer consoles, or other "talkback boxes." The Model 41's mounting location will dictate the length of the cable runs needed to link the unit with the connected devices. In some cases the location choice is already established. For example, in field broadcast applications the Model 41 will almost always be located in a production truck or trailer. But in fixed applications it may be possible to select the Model 41's mounting location so as to minimize cable length. In general, shorter cables will lead to more reliable and consistent system performance. It's also helpful if a technician can readily view and access the monitor section that is located on the right side of the Model 41's front panel. The output status LEDs and levels meters can serve important roles in ensuring correct IFB circuit operation. Access to the headphone output jack and level control can also be useful.

Mounting the Model 41

Once the desired mounting location has been selected, the Model 41 will require one space (1.75 vertical inches) in a standard 19-inch (48.3 cm) equipment rack. Secure the unit into the equipment rack using two mounting screws per side.

Audio Input Connections

The Model 41 has eight line-level audio inputs, arranged as four 2-channel pairs. Each pair serves one of the four IFB circuits. Each IFB circuit, along with its two associated audio inputs, is completely independent. Literally any audio source

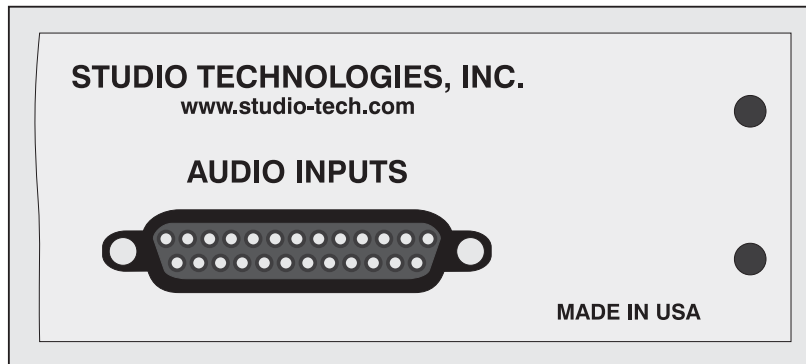

Figure 1. Detail of back panel showing connector used for audio inputs

with a nominal operating level in the range of +4 dBu can be successfully connected. Transformer coupled, the inputs are compatible with balanced or unbalanced signals. In many applications the analog outputs from digital matrix intercom systems will be connected to the Model 41.

For on-air television applications the IFB sources are generally configured to provide a single- or dual-channel cue “feed” to talent personnel. In such cases channel one of a pair is generally designated as the “interrupt” channel while channel two is the “program” channel. For other broadcast applications, such as live radio, it’s possible that a stereo cue source will be connected. In this situation the left source would be connected to input channel one while the right source would be connected to input channel two. This might also be the case with other professional audio applications, such as recording and post-production.

Audio input connections are made by way of one female 25-pin D-subminiature connector which is located on the Model 41’s back panel. A cable harness is required with a 25-pin D-sub plug (male) on one end and the desired mating connectors on the other. This cable harness is not supplied by Studio Technologies. (Note that

in some locations the term “cable loom” may be used instead of “cable harness.”) The wiring scheme used by the D-sub complies with the now-ubiquitous one made familiar by TASCAM® with their DA-88® product. A wiring harness prepared for connection to the Model 41’s audio inputs is identical to a DA-88-style input harness. Please refer to Figures 2 and 3 for connection details. Note that unlike a DA-88-style harness, the Model 41’s D-sub

Connections	Signal High (+)	Signal Low (-)	Shield
IFB Circuit 1-Interrupt	24	12	25
IFB Circuit 1-Program	10	23	11
IFB Circuit 2-Interrupt	21	9	22
IFB Circuit 2-Program	7	20	8
IFB Circuit 3-Interrupt	18	6	19
IFB Circuit 3-Program	4	17	5
IFB Circuit 4-Interrupt	15	3	16
IFB Circuit 4-Program	1	14	2

Notes: 1) Connector type on Model 41 is 25-pin D-subminiature female. Installer must provide plug (male). Connector uses 4-40 threaded inserts for locking with mating plug.

2) Wiring scheme follows TASCAM DA-88 convention. Standard DA-88-style wiring harnesses are directly compatible, with the exception of 4-40 screw threads being required.

Figure 2. Connections for Audio Inputs using IFB Nomenclature

Connections	Signal High (+)	Signal Low (-)	Shield
IFB Circuit 1-Channel 1	24	12	25
IFB Circuit 1-Channel 2	10	23	11
IFB Circuit 2-Channel 1	21	9	22
IFB Circuit 2-Channel 2	7	20	8
IFB Circuit 3-Channel 1	18	6	19
IFB Circuit 3-Channel 2	4	17	5
IFB Circuit 4-Channel 1	15	3	16
IFB Circuit 4-Channel 2	1	14	2

- Notes:** 1) Connector type on Model 41 is 25-pin D-subminiature female. Installer must provide plug (male). Connector uses 4-40 threaded inserts for locking with mating plug.
- 2) Wiring scheme follows TASCAM DA-88 convention. Standard DA-88-style wiring harnesses are directly compatible, with the exception of 4-40 screw threads being required.

Figure 3. Connections for Audio Inputs using Dual-Channel Nomenclature

connector's hold-down screws use 4-40 threads. This complies with the original design standard for D-subminiature connectors which used English rather than metric thread pitch.

The Model 41's audio input circuits have a nominal signal level of +4 dBu. They are transformer coupled, have a nominal impedance of 10 k ohms, and compatible with balanced or unbalanced sources. Balanced sources should be wired so that signal high is connected to the + pins, signal low to the - pins, and shield to the shield pins. With unbalanced sources, connect signal high to the + pins, and shield to both the - and the shield pins. If connecting an unbalanced source in this manner results in hum or noise, try connecting signal high to the + pins, and shield to the - pins; leave the shield pins unterminated.

As previously mentioned, the Model 41 is compatible with matrix intercom systems from Riedel. Appendix A, located near the end of this user guide, provides detailed connection information.

IFB Circuits

As mentioned previously, the Model 41 has four independent IFB output circuits each supplying DC power and two channels of unbalanced audio. The IFB circuits are designed to connect to a variety of devices that conform to the broadcast IFB standard. In this implementation pin 1 is used for a combination of shield, DC power return, and audio common; pin 2 supplies a combination of DC power and one channel of unbalanced audio; pin 3 supplies a second channel of unbalanced audio. The DC power supplied on pin 2 is 30 volts nominal with a maximum current of nominally 200 milliamperes. The audio superimposed on the DC power has a nominal signal level of -10 dBu. Its audio source is the channel one audio input associated with that specific IFB circuit. The audio on pin 3 also has a nominal signal level of -10 dBu. Its audio source is the channel two audio input channel associated with that specific IFB circuit.

The Model 41's IFB circuits are interfaced using four 3-pin male XLR-type connectors which are located on the unit's back panel. The associated interface cables, one for each IFB circuit, must be terminated with 3-pin female XLR-type connectors. In most cases the IFB circuits should be wired by way of an input/output connector panel rather than directly to the external devices. It's also recommended that the panel have "mults" (multiple connectors)

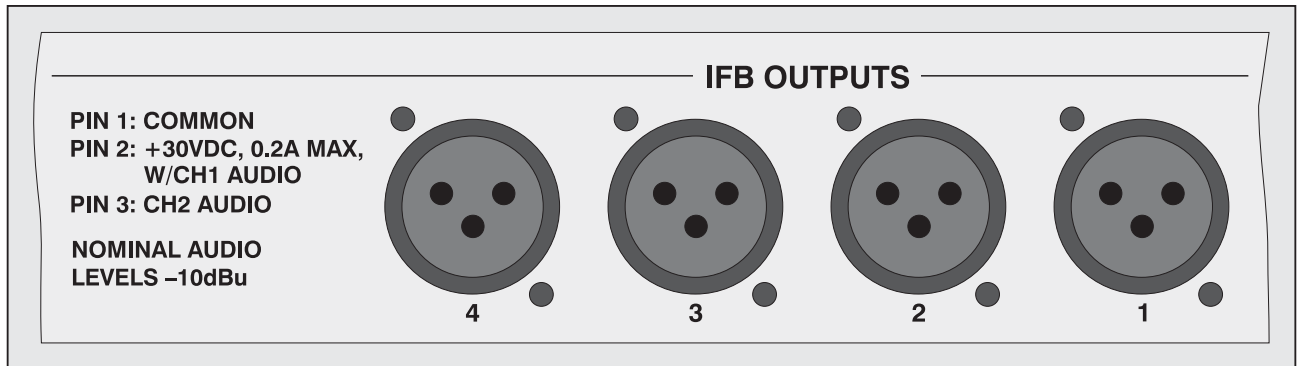

Figure 4. Detail of back panel showing IFB circuit output connectors

for each of the IFB circuits. For troubleshooting purposes it also may be useful to have the IFB circuits pass through points on an audio patch bay.

The type of interconnecting cable used between the Model 41's IFB circuits and the user devices will vary by application. In a fixed installation it would be typical to use 22 AWG, shielded, stranded cable in either a single- or 2-pair configuration. With single-pair cable, pin 1 should be connected to shield. Pins 2 and 3 would connect to the cable pair.

If 2-pair cable is used, pin 1 should connect to one side of each pair, with pin 2 going to one side of pair one and pin 3 going to one side of pair two. The shields can either go only to the XLR connector shells, or to both the connector shells and pin 1. Shielding unbalanced audio signals can be a tricky proposition. It is recommended that the focus be on using excellent twisted-pair cable, rather than worrying about whether or not it is shielded. The typical foil shields used in much of the contemporary audio cable generally offers very limited effectiveness. The best rule to follow is to try to minimize exposure to large noise sources. (Okay, so that's hardly ever practical but at least it's a nice dream!)

In the event that very long cable runs are required, the resistance of the cable can impact the DC power supplied by the Model 41. There's no way to get around the fact that some DC voltage will be dropped by the interconnecting cable. A simple "ohms law" calculation will tell you the impact a specific cable run will have. You'll need to know the current draw of the connected device(s), the minimum voltage required by the connected device(s), and the resistance of the cable's conductors. This is generally stated as ohms per 1000 feet. Make sure that you account for the resistance in both the pin 1 and pin 2 legs! In general, if there is the potential for a cable-length problem, moving to a more substantial cable gauge, such as 20, 18, or 16 can be effective.

AC Mains Power

The Model 41 operates directly from AC mains power of 100 to 230 V, 50/60 Hz. Being a "universal input" device, there are no switches to set or jumpers to install to match a location's nominal mains voltage. For locations that have a mains power source of 240 volts, contact Studio Technologies for confirmation that a direct connection can be made.

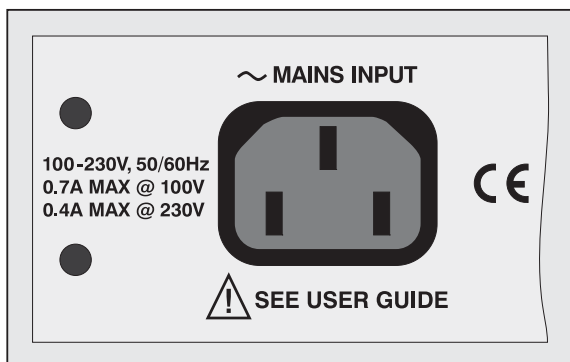

Figure 5. Detail of back panel showing AC mains power connector

The Model 41 uses a 3-pin IEC 320 C14-type inlet connector to mate with a detachable mains cord. For units shipped to North America and Japan a cord is supplied that has a North-American (NEMA 15L) standard plug on one end and an IEC 320 C13-type connector on the other. Units bound for other destinations require that the appropriate cord be obtained. The wire colors in the mains cord must conform to the internationally recognized color code and should be terminated accordingly:

<u>Connection</u>	<u>Wire Color</u>
Neutral (N)	Light Blue
Line (L)	Brown
Earth/Ground (E)	Green/Yellow

Safety Warning: The Model 41 does not contain an AC mains disconnect switch. As such, the AC mains cord plug serves as the disconnection device. Safety considerations require that the plug and associated inlet be easily accessible to allow rapid disconnection of AC mains power should it prove necessary.

As soon as AC mains power is applied the Model 41 will begin its power-up sequence. As a “boot up” indication each of the monitor section’s status LEDs will light in an ascending order. After that has completed one of the status LEDs will remain lit. The unit is now fully functional.

Post-Installation

Audio Input Source Level Adjustment

It’s important to confirm and, if required, adjust the level of the audio sources that are connected to the Model 41’s inputs. The monitor section’s dual 5-segment LED level meters will help make this task simple. Begin by using the pushbutton switch, located on the front panel, to select the IFB circuit that is going to be calibrated. Adjust the source levels so that the green LEDs light when typical audio signals are present. The desired nominal output level of the IFB circuits is -10 dBu. This is reflected in the top green LED being calibrated to, and labeled, -10 . The meters’ yellow LEDs, labeled -4 , should light infrequently, generally only when signal peaks are present. Achieving a precise level calibration is not critical. But getting the levels within the optimum range is very important!

It’s likely that the initial levels provided by analog ports on a digital matrix intercom system won’t be an exact match with the Model 41’s inputs. This shouldn’t pose a problem as the computer control available on contemporary intercom systems should make level adjustment very simple. From our research we found that

the Clear-Com Eclipse™ system specifies a nominal level of 0 dBu. Since their headroom is listed as greater than 18 dB, increasing the nominal level of their analog output ports by 4 dB (to achieve the desired +4 dBu) should be acceptable. RTS in their ADAM™ and ZEUS™ systems specify nominal output levels of +8 dBu. With these systems correct Model 41 performance would be provided by reducing the ports' output levels by 4 dB. With the Artist™ system from Riedel, the analog ports have a nominal level of +6 dBu. A 2 dB reduction in their output level would be beneficial. In reality, a signal with a nominal level that deviates somewhat from precisely +4 dBu will be acceptable. But with the power of contemporary computer-controlled intercom systems, there's no reason why a precisely calibrated system can't be easily implemented.

Audio Integrity

At this stage the Model 41 should have been installed and the input levels adjusted as required. The unit should now be ready for many years of excellent performance. But before turning to another task, performing a final Model 41 "reality check" is highly recommended. Using the monitor section, along with a pair of high-quality stereo headphones, carefully listen to each channel associated with the four IFB circuits. Ensure that the correct audio sources are assigned to the correct IFB circuits. Confirm that all interrupt channels have the correct audio levels as they switch from normal audio to interrupt content. Overall, the audio quality should be excellent, with no hum, noise, hiss, or other objectionable content. Should any issues be detected, now is the time to

work them out. Presenting IFB circuit users with a correctly implemented system will make life better for everyone involved!

Operation

Overall, the Model 41 is designed for continuous operation with no adjustment or maintenance required. On the input side, maintaining the correct level coming from the audio sources is very important. As for the IFB outputs, the cabling that connects the Model 41 to the user devices must remain free of full or partial short circuits. And the total current draw of the connected user devices must remain at 200 milliamperes or less.

The audio and DC voltage monitor functions will assist users in confirming that correct operation is taking place. In addition, the under-voltage shutdown function will help to protect the IFB output circuitry and connected user devices should a fault condition be detected. The "heart" of the monitor section is logic circuitry created by a microcontroller integrated circuit along with its associated firmware. This combination adds "smarts" to otherwise fairly pedestrian functions.

Using four electromechanical relays, the audio monitor section accesses the IFB circuits directly on pins 2 and 3 of the output connectors. This ensures that the impact of the actual wiring and connected user devices is monitored, rather than just observing something internal to the Model 41's circuitry. Pin 2 of each of the four IFB output connectors is also connected, by way of interface circuitry, to analog-to-digital converter inputs on the processor. This allows the DC output voltages to be continuously monitored.

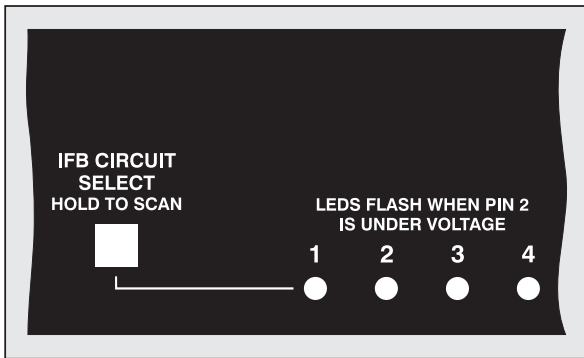

Figure 6. Detail of front panel showing four status LEDs and associated pushbutton switch

Associated with the audio and DC voltage monitor functions are four status LEDs, one pushbutton switch, two 5-segment LED level meters, a rotary level control, and a headphone jack. The four monitor status LEDs are used to indicate which IFB circuit is currently being audio monitored as well as presenting the status of the DC output voltages. One of the LEDs is always lit, indicating which IFB circuit is currently being monitored by the meters and headphone output.

Audio Monitoring

The dual 5-segment LED level meters allow a direct observation of the audio levels present on pins 2 and 3 of the selected IFB circuit's output connector. In television broadcast settings, the left meter will typically display the "interrupt" signal while the right meter will display "program." A quick glance at the meters will give an accurate overall indication of a circuit's performance. During the initial power-up period, lasting approximately 10 seconds, the meters may be observed "bouncing" if the IFB circuit selected for monitoring is changed. This is normal, caused by DC blocking capacitors taking a minute or two to reach their final state.

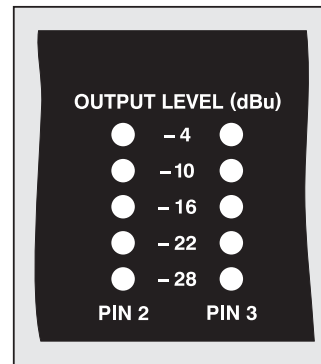

Figure 7. Detail of front panel showing dual 5-segment LED level meters

It's important to note that the meters on the Model 41 are calibrated differently from the typical "VU" scale. The level steps were selected so as to effectively display the IFB circuit's nominal -10 dBu signal level. The ballistics of the meters is also different, being a cross between VU and peak. The bottom four LEDs are green in color and indicate that signals are in the normal range. The top LED, yellow in color, lights when signals are 6 dB or greater above -10 dBu. A correctly functioning IFB circuit should find signals lighting the four green LEDs, with the yellow LED lighting only on peaks.

The headphone output allows audible monitoring of the selected IFB circuit. The 2-channel (stereo) output is compatible with virtually any pair of stereo headphones. As the output circuitry meets "pro audio" specifications, it's recommended that high-quality headphones be used. Pin 2 of the IFB circuit is the signal source for the left channel of the headphone output. Pin 3 of the IFB circuit is the source for the right channel. The rotary control adjusts the output level of both the left and right channels. Should it be necessary, there's no reason why the headphone output couldn't also be used as a line-level monitor output.



Figure 8. Detail of front panel showing headphone section

The front-panel-located pushbutton switch serves two purposes: selecting the source to be monitored and enabling the auto scan feature. To manually select an IFB circuit to be monitored, press and release the button until the status LED associated with the desired IFB circuit lights. Each press of the button will advance the circuit number to be monitored by one. A delay is built into the circuit selection process allowing a user to move from, for example, circuit 1 to circuit 3. Simply by pressing the button twice in rapid succession circuit 2 will be automatically skipped.

Unique to the Model 41 is its auto scan feature. Pressing and holding the button for two seconds will cause this feature to begin operation. In this mode the monitor source automatically “steps” through each IFB circuit, pausing for 8 seconds before moving on to the next. Ideally, this will allow technical personnel to observe a problem through casual viewing of the Model 41’s front panel.

DC Voltage Monitoring

The Model 41’s microcontroller integrated circuit, under software control, “watches” to ensure that the DC voltage present on pin 2 of each IFB output connector is

at an acceptable level. The low-voltage threshold for the Model 41’s nominal 30 volt DC output is 24 volts. As discussed in the previous section, the four LED indicators display which IFB channel is currently selected for audio monitoring. In addition, the LEDs provide an indication of the DC voltage status on the IFB circuits. An LED will “flash” at a moderate cadence if the voltage on its associated IFB circuit falls below the acceptable value. This can be caused by a temporary over-current or short-circuit condition, such as when inter-connecting user devices to active Model 41 IFB circuits using portable cabling.

An under-voltage condition that’s present for a continuous 4-second period will cause a fault condition to be recognized. The status LED associated with the problem IFB circuit will indicate this condition by flashing at a faster rate. In addition, the output voltage on that specific IFB circuit will automatically shut down to an essentially off condition. A 10-second “cool down” period will then take place, after which the output voltage will again become active. As soon as the output is enabled normal output voltage monitoring will again take place. A continuous short-circuit presented to an IFB output will result in a continuous 4-second on, 10-second off error cycle. It’s important to note that during the 10-second off period no voltage monitoring takes place. Removing the fault condition will not result in the output voltage immediately turning on again; the 10-second shut down period must first elapse.

Operating Parameters

As expected with professional equipment, whenever mains power is disconnected from the Model 41, the present operating

state will be stored in non-volatile memory. Specifically, the channel selected for audio monitoring and the status of the auto scan function will be recorded. This ensures that upon subsequent “power up” the unit will return to how it was left. If, for example, the auto scan function was active when the Model 41 was powered down, auto scan will begin once mains power is again connected.

Troubleshooting

If you’re having trouble getting the Model 41 up and running, this section may help. If you haven’t read the previous sections of this guide, you should do so before proceeding.

If the Model 41 Doesn’t Work At All

A source of AC mains power must be connected to the Model 41. The unit is a “universal input” type so that applying anything between 100 and 230 volts, 50/60 Hz is acceptable. Whenever mains power is connected the four monitor status LEDs should go through their power-up routine, lighting one at a time in sequence. If this does not occur confirm that AC mains power is active (“hot”) and that the cord is securely mated with the inlet connector on the Model 41’s back panel.

In all foreseeable situations, both normal and abnormal, the status LEDs should go through the normal power-up routine. However, it’s possible that if all four IFB circuits are being presented with a short-circuit condition, the internal 36 volt power supply may enter its protection mode and shut down. In this case no LED will light.

If this scenario occurs, even after confirming that mains power is correctly being applied, try removing the loads from the IFB circuits. The easiest way to do this is to remove the 3-pin female XLR-type connectors that are plugged into the Model 41’s back panel. If normal operation then begins, carefully check the IFB circuit wiring for fault conditions.

If the status LEDs still don’t go through their power-up routine, even after confirming that mains power is present and that the IFB circuits are not shorted, it’s likely that the unit requires factory service. For safety in the event of a major internal failure, the internal 36 volt power supply contains a fuse in series with the incoming mains power. This fuse will open (“blow”) only if a serious failure occurs inside the unit. The fuse is not field-replaceable. The Model 41 must be returned to the factory, or an authorized service location, for review and repair.

Maintaining Correct Input Signal Levels

The Model 41’s four 2-channel audio inputs are designed for nominal signal levels of +4 dBu. Applying signal levels significantly lower than +4 dBu will reduce the signal-to-noise ratio (raising the perceived noise floor) and can prevent the connected user devices from operating optimally. Applying signal levels significantly higher than +4 dBu will reduce the headroom and greatly increase the chance of reaching audio “clipping.” Obviously, these cautions are not unique to the Model 41, but apply to most audio equipment. The front-panel level meters provide an easy means of confirming that the Model 41 is being presented with the correct audio levels.

To confirm correct IFB circuit operation at locations away from where the Model 41 is installed, it's possible to use the Model 72 Level Meter/Interface, also available from Studio Technologies. The Model 72 is a compact, portable device that plugs directly into IFB or intercom circuits and provides two useful functions. Two 5-segment LED meters display the audio levels present on pins 2 and 3 of the connected circuit. In addition, two "dry" line-level audio outputs are provided. Complete information on the Model 72 is available on the Studio Technologies website.

Maintaining Correct IFB Circuit Current Draw

Each of the four IFB circuits is designed to provide up to 200 milliamperes of DC current. By design, the IFB circuits are protected so that an overload condition, or even a complete short circuit, should not cause damage. Exceeding 200 milliamperes for more than a few seconds will typically cause the auto shut down mode to become active. A continuous overload condition will cause the output voltage to cycle through a 4-seconds on, 10-seconds off sequence. Restoring the output load to be within the rated 200 milliamperes will allow the output to again operate normally. In extreme cases, such as where the Model 41 is located in an environment with elevated temperatures, a few minutes may be required from the time an overload condition is removed to when normal operation will again take place. Please don't test the Model 41's ability to sustain frequent overload or short-circuit conditions! The long-term reliability of the unit can be impacted by the stress caused by these fault conditions.

The four status LEDs make it simple to know if an excessive load, or a short circuit, is being placed on one or more of the IFB circuits. The LEDs provide a direct indication of the IFB circuits' DC output voltage. Each output voltage is directly related to the amount of current being drawn, as well as indicating when its output circuit has entered protection mode and essentially shut down. During normal operation the DC level on pin 2 of an output circuit will range from approximately 28 to 30 volts. An LED will begin to flash on and off if the level falls below approximately 24 volts DC. This will occur when the current draw is greater than nominally 200 milliamperes. As previously discussed, if the fault lasts for more than 4 seconds the LED will flash at a faster rate. In addition, the DC output will shut down for a 10-second period.

There's really only one piece of advice when it comes to understanding how to use the under-voltage status LEDs: if they're flashing there's a problem that must be corrected! The most likely cause will be a wiring fault that causes a partial or full short circuit between pin 1 (common) and pin 2 (power with audio) on the IFB circuit's XLR-type output connectors. Another cause can be due to problems with the IFB user devices. Either a defective user device can be drawing too much current, or too many user devices end up being connected to the same IFB circuit. Troubleshooting an IFB circuit problem should prove quick and easy. Begin by disconnecting the IFB user devices. Observe the status LED and see if the problem has gone away. If not, review the interconnecting cables and find the fault condition. Within 10 seconds of the problem being "cleared" the status LED will stop flashing.

Determining the actual IFB circuit current draw won't often be required but can be useful in a tough troubleshooting situation. This measurement can be performed using any good-quality digital multimeter. Begin by setting the meter to measure DC current. Then place the meter leads in series with the pin 2 lead of the XLR-type connector associated with the IFB circuit to be tested. The easiest way to measure the pin 2 current is to create a simple adapter cable using one female and one male 3-pin XLR-type connector. Connect pin 1 on both connectors together. Connect pin 3 on both connectors together. Connect separate wires to the pin 2 leads on both connectors. Then connect the meter leads to these two wires. The meter will indicate the DC current being drawn while normal operation of the connected device(s) takes place. Be certain to connect the maximum number of devices that might be powered by the IFB circuit. That is, measure the worst-case condition and ensure that the load is within the rated 200 milliamperes output. If possible, leaving a 10 or 20% reserve margin is a good practice.

Technical Notes

Software Revision Number

For Model 41 units with serial number 230 and later a special power-up sequence allows the software version number to be displayed. This is useful when working with factory personnel on applications support and troubleshooting situations. The four IFB circuit status LEDs are used to display the software version number with a range of 1 through 4. Refer to Figure 9 for a detailed view of the LEDs

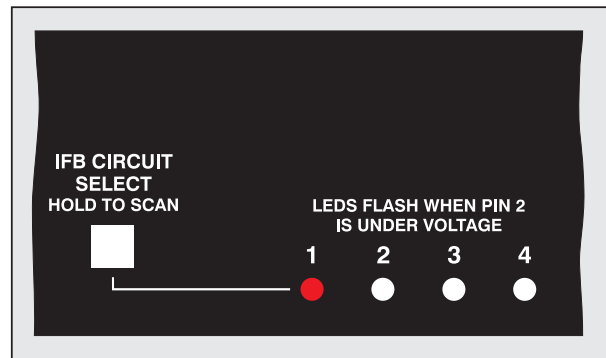

Figure 9. Detail of front panel showing the status LEDs that display software version. In this example, the software version is 1.1.

and the corresponding software version numbering scheme. The Model 41's initial software release for hardware with serial numbers 230 and later is version 1.1. This is represented by the LED on the far left side being lit.

To display the Model 41's software version is very simple. From the powered-down state, press and hold the front-panel pushbutton switch. Apply mains power while continuing to press the button. The normal power-up sequence will not occur but instead one of the status LEDs will light. After the software version number has been "read" the pushbutton can be released. At this time the unit will begin its normal power-up sequence.

Note that while it's easy to determine which software version is loaded into the Model 41 a replacement microcontroller integrated circuit is required to update it. Contact the factory for details. Also, Model 41 units with serial numbers of less than 230 do not support display of their software version. With these units applying mains power will always cause the normal power-up sequence to take place.

Cable Length

There are no hard and fast rules defining the maximum cable length possible when connecting user devices to Model 41 IFB circuits. The maximum cable length is directly related to the amount of resistance in the connecting cable; the lower the resistance per foot (or meter), the longer the cable can be. (Although cable capacitance affects high-frequency performance, resistance is the limiting factor in this case.) For example, a traditional 20 AWG microphone-type cable is Belden 8412, which has 10.9 ohms resistance per conductor per 1000 feet. Since we're using two conductors to carry the signal (pins 1 and 2) you'd get 21.8 ohms per 1000 feet of cable. By knowing the cable resistance value, along with the minimum voltage and maximum load current required by an IFB user device, a simple "ohms law" calculation will tell you the maximum cable length.

Let's use the example of a Studio Technologies Model 200 Announcer's Console being connected to a Model 41 IFB circuit. We'll select Belden 8412 as the interconnecting cable. For correct operation, the Model 200 needs at least 24 volts DC between pins 1 and 2 of its IFB input connector. It has a current draw of 95 milliamperes. The Model 41's IFB circuit presents an output voltage of 30 volts across pins 1 and 2 and can supply a maximum current of 200 milliamperes. (As the Model 200's current draw is well within the Model 41's capability, this is not a limiting factor.) The difference between the voltage supplied by the Model 41 (30 volts) and the voltage required by the Model 200 (24 volts) allows a 6 volt maximum drop over the interconnecting cable. Using the current draw and maximum voltage drop figures, the maximum cable resistance can easily be

calculated: 6 volts divided by 0.095 amperes equals 63 ohms. And finally, with 8412's 21.8 ohms (total) per 1000 feet of cable, a maximum of 2890 feet of cable can be used and still be less than or equal to 63 ohms. Using this example as a guide, entering the appropriate values will allow you to determine the maximum cable length for your application.

Cabling Issues – Crosstalk

The Model 41's IFB circuits conform to a broadcast industry standard for sending DC power and two channels of audio over a single pair with shield audio cable. This implementation allows standard portable cables, such as are used for microphone signals, to interconnect various IFB user devices. This method is undoubtedly convenient and practical, but is not without limitations. The main audio quality issue is the possibility of crosstalk between the two audio channels. This issue arises due to the capacitance presented by the two wires that form the twisted pair. The greater the capacitance presented and the longer the cable run, the greater the crosstalk will become. Is this normally a problem during actual use? No. But it's something that should be noted.

Studio Technologies did some experimenting with various cables and the crosstalk that was created. For example, a 1000-foot reel of 24-gauge 2-pair unshielded telephone cable was used to link a Model 41 IFB circuit with an IFB user device. One pair carried the pin 2 (DC with channel 1 audio) and pin 3 (channel 2 audio) connections. One wire from the second pair carried the pin 1 (DC and audio common) connection. The inter-channel crosstalk in the voice audio band was on the order of -45 dB. Is this a good value for "professional" audio? Of

course not. But for the intended talent cueing applications it should be fine. In almost all cases the audio signals being carried are somewhat or fully phase-coherent. A bit of one channel getting into the other won't even be noticed, especially since monitoring is generally done using headsets, headphones, or earpieces.

Is it possible to reduce the crosstalk that is created? Absolutely, as long as a non-standard cable connection is made. This becomes a trade-off between an improved crosstalk figure and ease of installation and use. Using two full pairs can significantly reduce crosstalk. Several connection schemes are possible; the exact one selected will depend on the specific installation and personal technical philosophy. Two unshielded twisted pairs can be effectively used. The first pair would carry the DC and channel 1 audio signal and common. The second pair would carry the channel 2 audio signal, again along with common. There will still be some capacitance between the conductors carrying the two audio channels but it should be significantly less. Two shielded pairs can also be used as was discussed in the Installation section of this user guide.

Superior Power Delivery and Audio Quality

As previously discussed, one of the Model 41's strengths is its ability to very effectively deliver energy to the connected IFB user devices. This allows more devices to be supported over longer cable runs. How does the Model 41 accomplish this? Simply by having circuitry that is superior to that used in most of the "industry-standard" equipment. In most IFB interface devices, an adjustable voltage regulator integrated circuit is used as a

combination of audio modulator and current limiter. While this is a simple and inexpensive solution, it's not without significant limitations. The major problem with this method is the type of voltage-current "knee" that is created. As the load current increases past about 50% of the rated maximum the output voltage begins to decrease. This means that the usable power delivered to the connected device(s) will start to drop well before the rated output is reached. This limitation will become significant in applications that use long cable runs. As the IFB circuit voltage begins to drop problems with user device performance can occur. Contrast this situation with the performance provided by the Model 41. The DC voltage supplied by its IFB circuits won't "poop out" when loaded over its 0 to 200 milliamperes range. This will allow IFB belt pack and announcer's console devices to work correctly in many more applications. Figure 10 shows the IFB circuit voltage-current curves for the RTS 4000-series and the Model 41 Interface. The performance differences are quite interesting.

It's interesting to note the reason why typical IFB circuit audio quality is less than pristine. It's not hard to notice the background "hiss" that is always present on pin 2 (DC with channel 1 audio) of the interface connector. Technically, it's white noise that comes from the adjustable voltage regulator being used as an "AM" modulator and current limiter. The noise is an artifact of the design topology and simply can't be overcome. How does Studio Technologies know this? Because our first "breadboard" designs used this method and achieved the same poor results! Only after the problem came to light did work on an improved circuit begin. The results were worth the effort.

Model 41

Interface

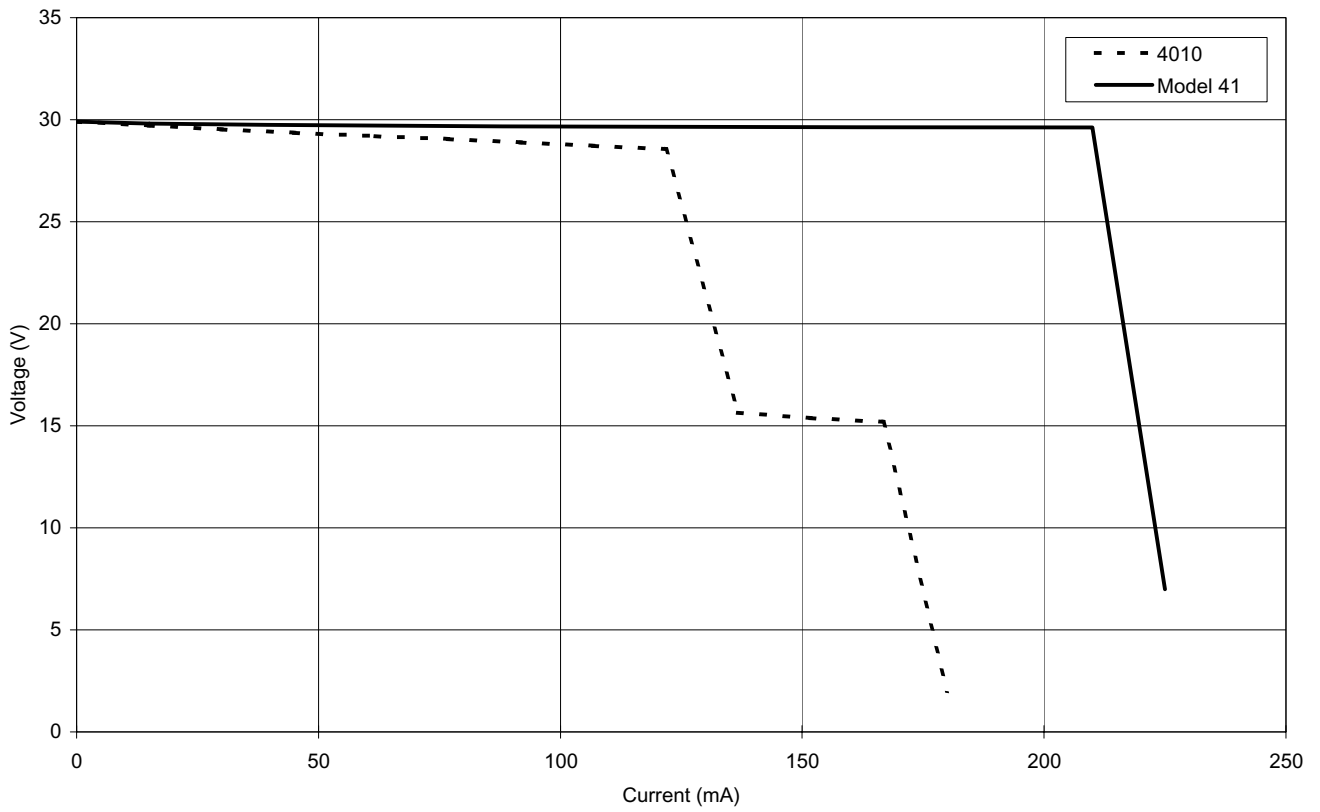

Figure 10. IFB Circuit Voltage-Current Curves for RTS 4000-Series and Model 41 Interface

Specifications

General Audio:

Frequency Response:

Pin 2 Outputs (DC with Channel 1 Audio):
20 Hz-20 kHz ± 2.5 dB (80 Hz-20 kHz ± 0.25 dB)

Pin 3 Outputs (Channel 2 Audio): 20 Hz-20 kHz
 ± 0.25 dB

Distortion (THD+N): 0.01%, measured at 1 kHz,
+4 dBu, pin 2 outputs (DC with channel 1 audio)

S/N Ratio: 80 dB, ref +4 dBu out, 20 Hz-20 kHz,
pin 2 outputs (DC with channel 1 audio)

Crosstalk: 81 dB, typical, ref +4 dBu in,
20 Hz-20 kHz

Audio Inputs: 8, organized as four 2-channel
inputs

Type: transformer balanced, capacitor coupled,
compatible with balanced or unbalanced sources

Impedance: 10 k ohms, nominal

Nominal Level: +4 dBu

IFB Output Circuits: 4

Type: DC power with two channels of unbalanced
audio

Connections: common on pin 1, DC (+30 V
nominal) modulated with channel 1 audio (-10 dBu
nominal) on pin 2, and channel 2 audio (-10 dBu
nominal) on pin 3

Maximum Audio Output Level:

Pin 2: +9 dBu with +23 dBu on audio input

Pin 3: +14 dBu with +28 dBu on audio input

DC Current Output: 200 mA maximum

Monitor Section – Headphone Output:

Type: 2-channel (stereo), drives headphones by
way of 100 ohm series resistors

Compatibility: intended for connection to head-
phones with impedance of 100 ohms or greater

Maximum Voltage: 8 Vpp, 100 ohm load

Monitor Section – Output Voltage Detection:

Measures DC voltage level directly on pin 2 of IFB
circuit output connectors. Status LEDs flash when
level is less than approximately 24 volts DC.

Connectors:

Audio Inputs: 25-pin D-subminiature female,
4-40 threads

IFB Outputs: 3-pin male XLR-type

Headphone Output: ¼-inch 3-conductor phone
jack

AC Mains: 3-blade, IEC 320 C14-compatible
(mates with IEC 320 C13)

AC Mains Requirement:

100-230 volts, 50/60 Hz, 0.7 A maximum @ 100
volts, 0.4 A maximum @ 230 volts

Dimensions (Overall):

19.00 inches wide (48.3 cm)

1.72 inches high (4.4 cm)

9.58 inches deep (24.3 cm)

Mounting: one space in a standard 19-inch rack

Weight: 6.6 pounds (3.0 kg)

Specifications and information contained in this
User Guide subject to change without notice.

Appendix A

Interfacing Riedel® Artist™ Matrix Intercom Systems with the Model 41 Interface

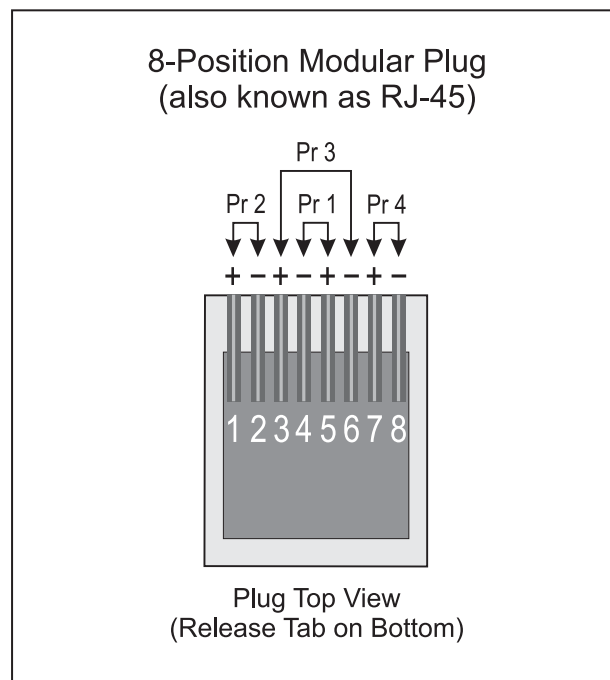
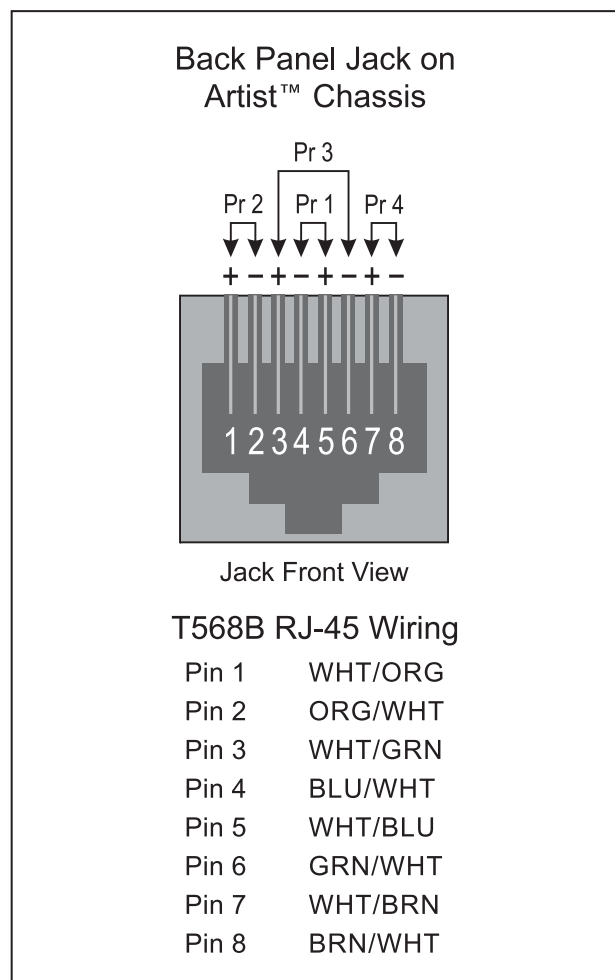
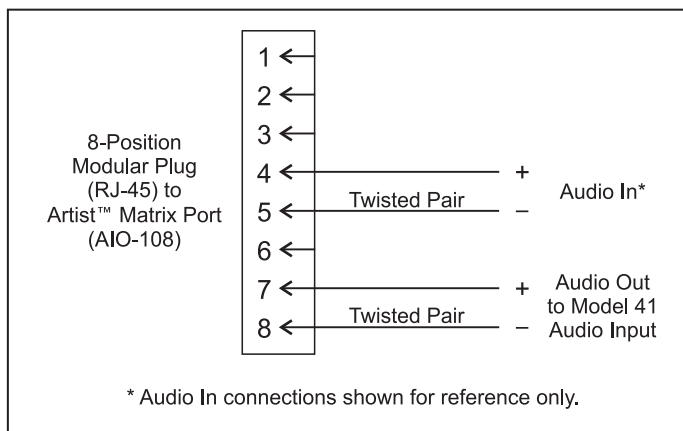

Information courtesy of Riedel Communications Inc.

— CIRCUITRY IDENTICAL FOR IFB CIRCUITS 2-4 —

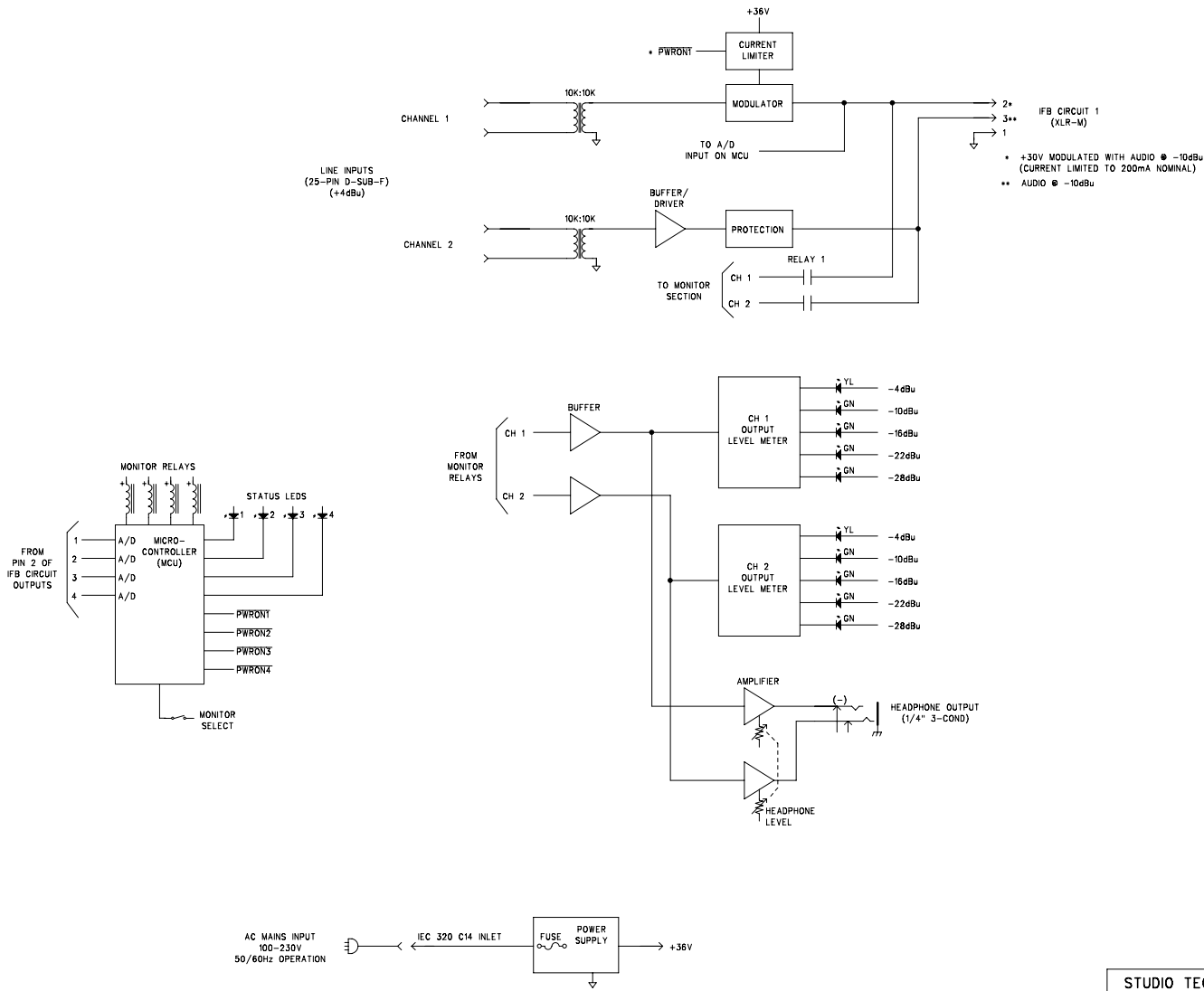

M41BD_B

STUDIO TECHNOLOGIES, INC.		
MODEL 41 INTERFACE BLOCK DIAGRAM		
DRAWING NO.	DATE	PAGE
31123	11/01/06	01 OF 01

* FOR SN 00230 AND LATER

